

J518 Split & Captive Flange

CODE 61 SPLIT FLANGE													
*PART NO.	**KIT PART NO.	FLANGE SIZE	A	B	C	D	E	F	G	H	J	MOUNTING HARDWARE	
												O-RING	HHCS
8SF-2	8SFO	.50	.86	2.12	1.500	.75	.50	1.219	.955	.245	.350	210	5/16-18X1.25
12SF-2	12SFO	.75	.98	2.56	1.875	.88	.56	1.531	1.265	.245	.417	214	3/8-16X1.25
16SF-2	16SFO	1.00	1.11	2.75	2.062	.94	.62	1.781	1.515	.295	.417	219	3/8-16X1.25
20SF-2	20SFO	1.25	1.39	3.12	2.312	.88	.56	2.031	1.720	.295	.472	222	7/16-14X1.50
24SF-2	24SFO	1.50	1.58	3.69	2.750	1.00	.62	2.406	2.000	.295	.524	225	1/2-13X1.50
32SF-2	32SFO	2.00	1.86	4.00	3.062	1.03	.62	2.844	2.470	.355	.524	228	1/2-13X1.50
40SF-2	40SFO	2.50	2.09	4.50	3.500	1.50	.75	3.344	2.950	.355	.524	232	1/2-13X1.75
48SF-2	48SFO	3.00	2.53	5.31	4.188	1.62	.88	4.031	3.580	.355	.657	237	5/8-11X1.75
56SF-2	56SFO	3.50	2.70	6.00	4.750	1.12	.88	4.531	4.030	.422	.657	241	5/8-11X2.00
64SF-2	64SFO	4.00	2.95	6.38	5.125	1.38	1.00	5.031	4.530	.422	.657	245	5/8-11X2.00

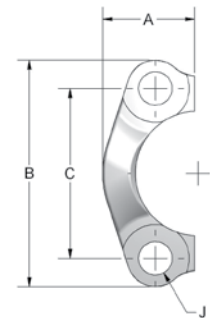

CODE 62 SPLIT FLANGE													
*PART NO.	**KIT PART NO.	FLANGE SIZE	A	B	C	D	E	F	G	H	J	MOUNTING HARDWARE	
												O-RING	HHCS
8SFX-2	8SFXO	.50	.89	2.22	1.594	.88	.62	1.281	.970	.285	.350	210	5/16-18X1.25
12SFX-2	12SFXO	.75	1.14	2.81	2.000	1.12	.75	1.656	1.280	.325	.417	214	3/8-16X1.50
16SFX-2	16SFXO	1.00	1.33	3.19	2.250	1.31	.94	1.906	1.530	.355	.472	219	7/16-14X1.75
20SFX-2	20SFXO	1.25	1.48	3.75	2.625	1.50	1.06	2.156	1.750	.385	.524	222	1/2-13X1.75
24SFX-2	24SFXO	1.50	1.83	4.44	3.125	1.69	1.19	2.531	2.030	.475	.657	225	5/8-11X2.25
32SFX-2	32SFXO	2.00	2.20	5.25	3.812	2.06	1.44	3.156	2.660	.475	.811	228	3/4-10X2.75



Part # includes: (1) split flange half only

**Kit part # includes: (2) split flange halves, (4) hex head screws with flat washers, (1) Buna N O-Ring

Split flange halves are silver trivalent plated

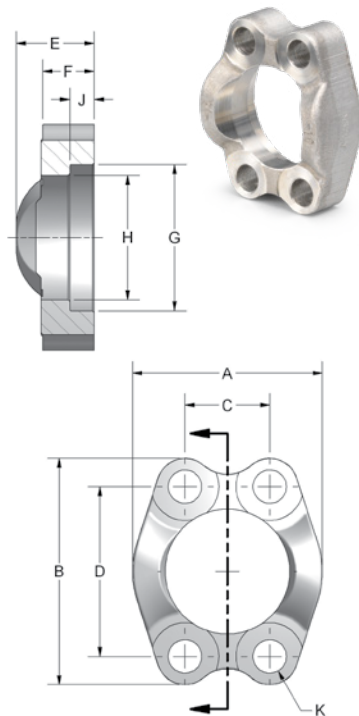

CODE 61 CAPTIVE FLANGE													
DRILLED PART NO.	TAPPED PART NO.	FLANGE SIZE	A	B	C	D	E	F	G	H	J	K	K UNC-2B
8SFW	8SFTW	.50	1.81	2.12	.688	1.500	.75	.50	1.219	.955	.245	.344	5/16-18
12SFW	12SFTW	.75	2.06	2.56	.875	1.875	.88	.56	1.531	1.265	.245	.406	3/8-16
16SFW	16SFTW	1.00	2.31	2.75	1.031	2.062	.94	.62	1.781	1.515	.295	.406	3/8-16
20SFW	20SFTW	1.25	2.88	3.12	1.188	2.312	.88	.56	2.031	1.720	.295	.469	7/16-14
24SFW	24SFTW	1.50	3.25	3.69	1.406	2.750	1.00	.62	2.406	2.000	.295	.531	1/2-13
32SFW	32SFTW	2.00	3.81	4.00	1.688	3.062	1.03	.62	2.844	2.470	.355	.531	1/2-13
40SFW	40SFTW	2.50	4.28	4.50	2.000	3.500	1.50	.75	3.344	2.950	.355	.531	1/2-13
48SFW	48SFTW	3.00	5.16	5.31	2.438	4.188	1.62	.88	4.031	3.580	.355	.656	5/8-11
56SFW	56SFTW	3.50	5.50	6.00	2.750	4.750	1.12	.88	4.531	4.030	.422	.656	5/8-11
64SFW	64SFTW	4.00	6.00	6.38	3.062	5.125	1.38	1.00	5.031	4.530	.422	.656	5/8-11

CODE 62 CAPTIVE FLANGE													
DRILLED PART NO.	TAPPED PART NO.	FLANGE SIZE	A	B	C	D	E	F	G	H	J	K	K UNC-2B
8SFXW	8SFXTW	.50	1.86	2.22	.718	1.594	.88	.62	1.281	.970	.285	.344	5/16-18
12SFXW	12SFXTW	.75	2.38	2.81	.937	2.000	1.12	.75	1.656	1.280	.325	.406	3/8-16
16SFXW	16SFXTW	1.00	2.75	3.19	1.093	2.250	1.31	.94	1.906	1.530	.355	.469	7/16-14
20SFXW	20SFXTW	1.25	3.06	3.75	1.250	2.625	1.50	1.06	2.156	1.750	.385	.531	1/2-13
24SFXW	24SFXTW	1.50	3.75	4.44	1.437	3.125	1.69	1.19	2.531	2.030	.475	.656	5/8-11
32SFXW	32SFXTW	2.00	4.50	5.25	1.750	3.812	2.06	1.44	3.156	2.660	.475	.781	3/4-10